

828nm DFB Laser diode for Seed Laser



Description:

The PL-DFB-828-A-A81 828nm DFB laser diode module made by LD-PD is a cost effective, highly coherent laser source. The DFB laser diode chip is packaged in an industry standard hermetically sealed 14 pin butterfly package with TEC and PD Built in. We special design the area only work in room Temperature. Our diode has good performance from 20-30°C.

Features:

- Narrow Linewidth < 2MHz
- Excellent wavelength control and stability
- Industry Standard 14 pin Butterfly package
- Mode-Hop free tuning
- Excellent reliability
- Customer specific wavelengths available

Optional:

- Tunable diode laser absorption spectroscopy
- Seed laser
- Fiber laser

Laser Specifications:

Tsub=25°C, CW bias unless stated otherwise

Parameter	Symbol	Min	Typ	Max	Unit
Centre Wavelength	λ	827.5	828.0	828.5	nm
Side Mode Suppression Ratio	SMSR	30	40		dB
Threshold Current	I _{th}		20	30	mA
Operating Current	I _{op}		80	120	mA
Chip output Power	P _f	10	20	30	mW
Quantum Efficiency	η	0.08	0.12		mW/mA
Current Tuning Coefficient	$\Delta\lambda/\Delta I$		0.015		nm/mA
Temperature Tuning Coefficient	$\Delta\lambda/\Delta T$		0.12		nm/K
Forward Voltage	V _f		1.3	2	V
Thermistor Resistance	R _T	9.5	10	10.5	K Ω
Thermistor Temp. Coefficient			-4.4		%/°C
Connector	FC/APC				

Spectrum:

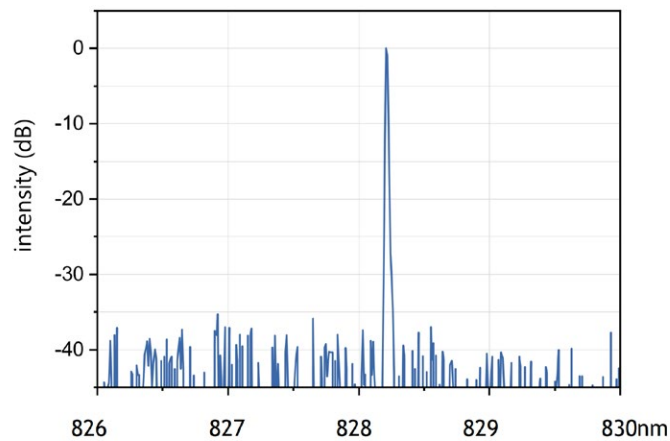

L-I Curve:

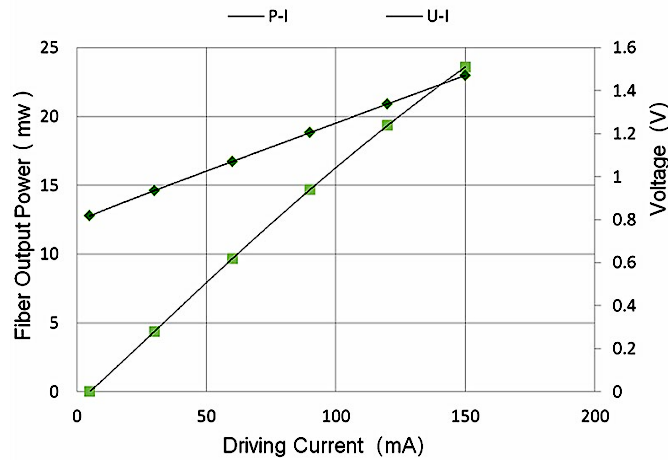

Tuning characteristics:

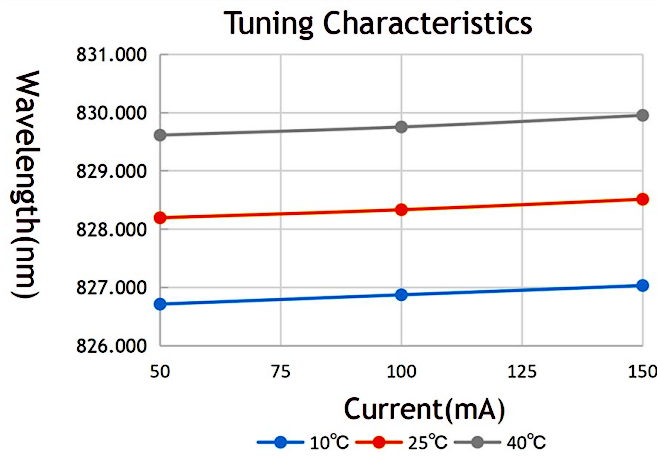

DFB Linewidth Testing Result:

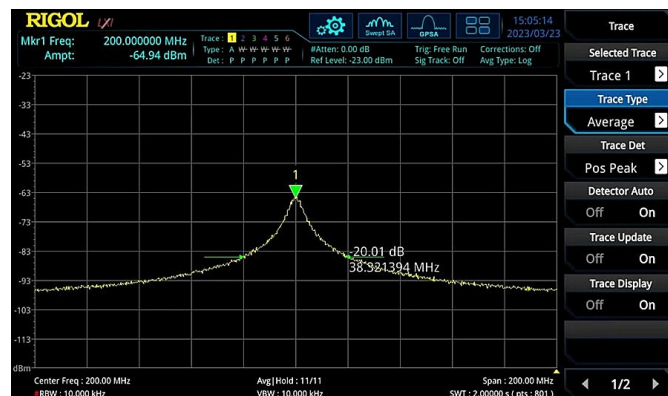

Beam Quality:

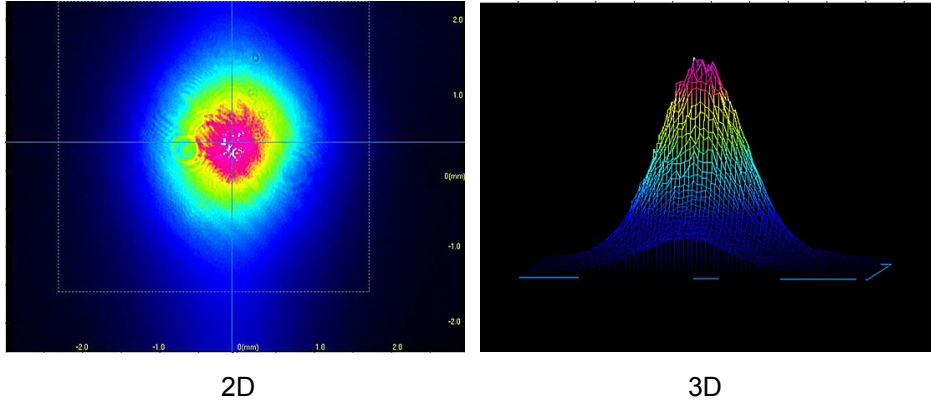

Package Size:

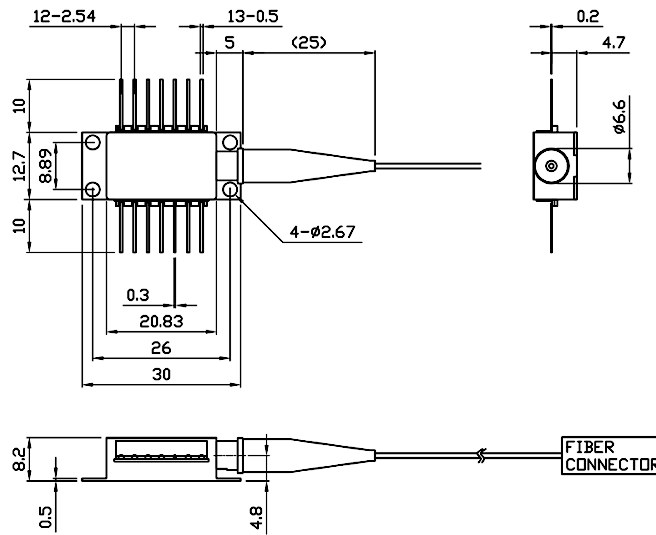

Pin Definition:

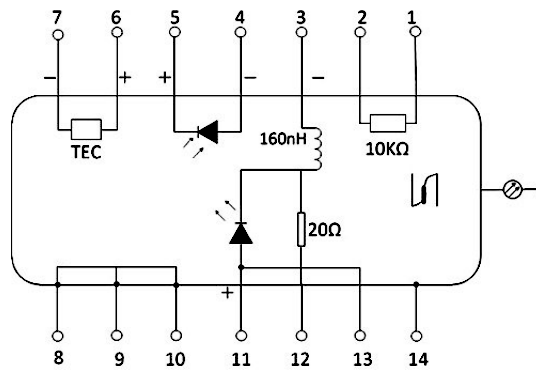

1	Thermoelectric Cooler (+)	8	N/C
2	Thermistor	9	N/C
3	PD Monitor Anode (-)	10	Laser Anode (+)
4	PD Monitor Cathode (+)	11	Laser Cathode (-)
5	Thermistor	12	N/C
6	N/C	13	Case Ground
7	N/C	14	Thermoelectric Cooler (-)

Absolute Maximum Ratings:

Item	Unit	Min	Typ	Max
Case Temperature	°C	-5	25	70
Chip Temperature	°C	+10	25	40
Operating Current	mA	0	180	250
Forward Voltage	V	0.8	1.2	2.1
TEC Current	A	-	1.2	1.2
Reverse Voltage(LD)	V	-	-	2.0
Reverse Voltage(PD)	V	-	-	20

OEM Info:

PL-DFB-□□□□-☆-A8▽-XX

□□□□: Wavelength

828: 828nm

1392: 1392nm

1512: 1512nm

1567: 1567nm

1653.7: 1653.7nm

☆: Output Power

A: 20mW

B: 50mW

▽: Wavelength Tolerance

1: ±1nm

2: ±2nm

XX: Fiber and Connector Type

SA=HI780+ FC/APC

SP=HI780+ FC/PC

PA=PM980 Fiber+ FC/APC

PP=PM980 Fiber+ FC/PC