

MDL-E-852/1~120mW



**NARROW LINEWIDTH  
DIODE LASER AT 852nm**

It features a narrow spectral linewidth, stable wavelength, long lifetime and easy operation. They are widely used in precision measurement, high resolution spectrum analysis, etc.



SPECIFICATIONS

Central wavelength (nm)	852±0.5
Operating mode	CW
Output power (mW)	>1, 10, 20, ..., 120
Power stability (rms, over 4 hours)	<3%, <2%, <1%
Transverse mode	Near TEM <sub>00</sub>
Spectral linewidth (nm)	<0.06 (<0.03, optional)
M <sup>2</sup> factor	<1.5
Beam diameter at the aperture (1/e <sup>2</sup> , mm)	~1.5
Beam divergence, full angle (mrad)	<2.0
Polarization ratio	>10:1 (>50:1, optional) Horizontal±5 degree (Vertical Optional)
Warm-up time (minutes)	<5
Beam height from base plate (mm)	30
Operating temperature (°C)	20~30
Power supply (100-240VAC)	PSU-A-D
Expected lifetime (hours)	10000
Warranty	1 year



MDL-E-852

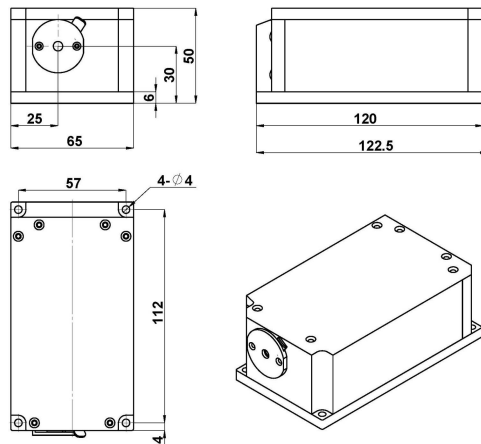

122.5(L)×65(W)×50(H) mm<sup>3</sup>, 1.0kg

PSU-A-D



162(L)×144(W)×70(H) mm<sup>3</sup>, 1.0kg